

- | | | | |
|------------|-------------------------|-----------|-----------------------------|
| PL | Instrukcja montażu | UA | Інструкція по установці |
| GB | Assembly instruction | H | Szerelési útmutató |
| D | Montageanleitung | RO | Instrucțiuni de montaj |
| SK | Návod na inštaláciu | FR | Instruction de montage |
| CZ | Pokyny k instalaci | IT | Istruzioni di montaggio |
| RUS | Инструкция по установке | ES | Instrucciones de ensamblaje |
| | | AE | تعليمات التجميع |

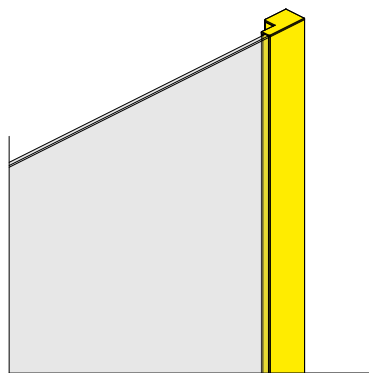

Idea +20mm

- | | | | |
|-----------|---------------------|------------|------------------------|
| PL | Profil poszerzający | RUS | Расширительный профиль |
| GB | Extension profile | UA | Розширений профіль |
| D | Verbreitungsprofil | RO | Profile de extensie |
| SK | Rozširovací profil | H | Toldóprofilok |
| CZ | Rozšiřující profil | | |

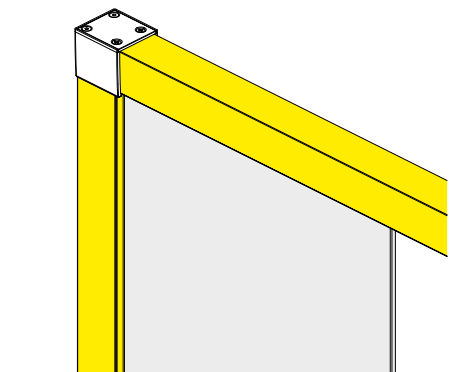
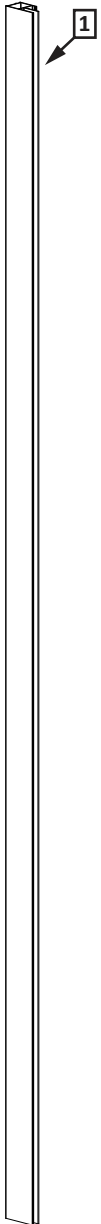
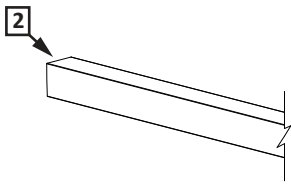

Nr Nr No. číslo počet № Sorszám Numar N° N° N° رقم	Oznaczenie Mark Bezeichnung Označenje Označení обозначение Jelölés Componenta Simbole Simbolo Símbolo علامة	Sztuk Pcs. Stück Kus KS штук Db. Bucati Pcs Pz Pzas قطع
IDEA PDD		
3. → 1.		1 → 1
4. → 2.		1 → 1
IDEA KDD		
3. → 1.		1 → 1
5.L → 2.L 5.R → 2.R		1 → 1 1 → 1
IDEA KDJ DRZWI/DOOR		
4.1. → 1.		1 → 1
6. → 2.		1 → 1

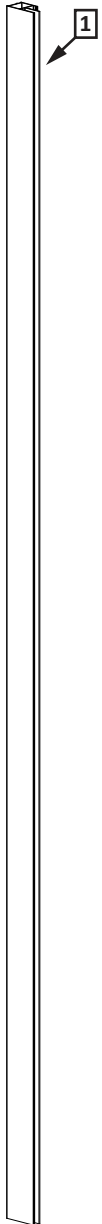
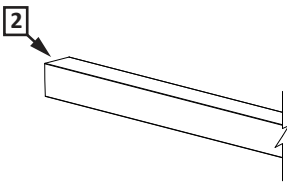

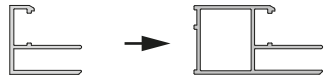
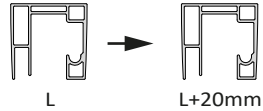
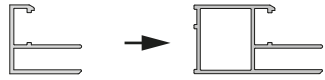
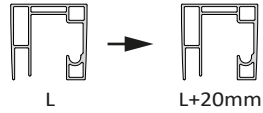
Nr Nr No. číslo počet № Sorszám Numar N° N° N° رقم	Oznaczenie Mark Bezeichnung Označení Označení обозначение Jelölés Componenta Simbole Simbolo Símbolo علامة	Sztuk Pcs. Stück Kus KS штук Db. Bucati Pcs Pz Pzas قطع
IDEA DWJ		
3. → 1.		1 → 1
7. → 2.	 L L+20mm	1 → 1
IDEA DWD		
3. → 1.		1 → 1
5. → 2.	 L L+20mm	1 → 1

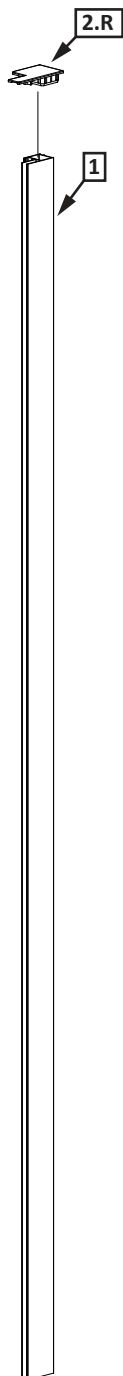

Nr Nr No. číslo počet № Sorszám Numar N° N° N° رقم	Oznaczenie Mark Bezeichnung Označenje Označení обозначение Jelölés Componenta Simbole Simbolo Símbolo علامة	Sztuk Pcs. Stück Kus KS штук Db. Bucati Pcs Pz Pzas قطع
IDEA KDJ <i>ŚCIANKA S1/SIDEWALL S1</i>		
4.2 → 1.		1 → 1
18.L → 2.R		1 → 1
18.R → 2.L		1 → 1

radaway 

IDEA

- | | | | |
|------------|-------------------------|-----------|------------------------------|
| PL | Instrukcja montażu | H | Szerelési útmutató |
| GB | Assembly instruction | RO | Instructiuni de montaj |
| D | Montageanleitung | FR | Instruction de montage |
| SK | Návod na inštaláciu | IT | Istruzioni di montaggio |
| CZ | Pokyny k instalaci | ES | Instrucciones de ensambleaje |
| RUS | Инструкция по установке | AE | تعليمات التجميع |
| UA | Інструкція по установці | | |